

# HT PP VNITŘNÍ ODPADNÍ SYSTÉM

HT PP INTERNAL DRAINAGE SYSTEM | HT PP HAUSABFLUSSSYSTEM | HT PP ВНУТРЕННЯЯ КАНАЛИЗАЦИЯ

## HTEP Paneláková odbočka

Double corner branch  
Doppleabzweige  
Панельные отводы

ART.	DN/DN/D	$\alpha$	Z1	Z2	balení ks
COLAA76	110/110/75 L	67°30'	112	198	10
COPAA76	110/110/75 P	67°30'	112	198	10
COLAA78	110/110/75 L	87°30'	112	198	10
COPAA78	110/110/75 P	87°30'	112	198	10

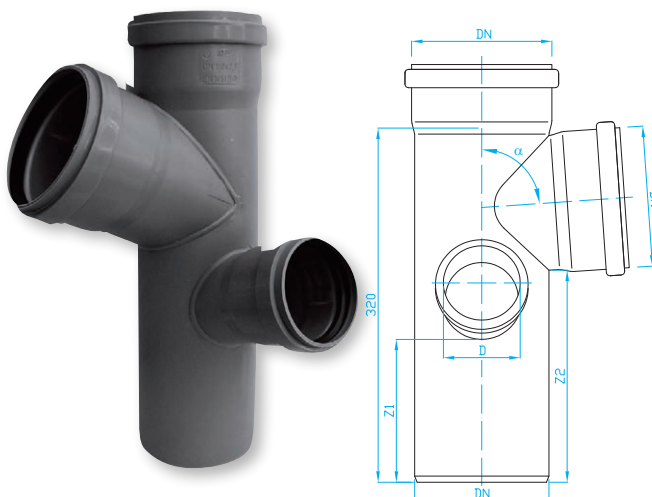

## HTDA Dvojitá odbočka

Double branch  
Doppleabzweige  
Панельные отводы

ART.	DN/D/D	$\alpha$	Z1	Z2	Z3	balení ks
COD5554	50/50/50	45°	12	61	61	10/1
COD5556	50/50/50	67°30'	20	41	41	10/1
COD5558	50/50/50	87°30'	28	30	30	10/1
COD7554	75/50/50	45°	5	75	130	10/1
COD7558	75/50/50	87°30'	25	25	113	10/1
COD7774	75/75/75	45°	20	85	170	8/1
COD7776	75/75/75	67°30'	28	59	59	10/1
COD7778	75/75/75	87°30'	40	40	145	10/1
CODA554	110/50/50	45°	17	104	91	10/1
CODA556	110/50/50	67°30'	8	73	54	10/1
CODA558	110/50/50	87°30'	28	60	32	10/1
CODA774	110/75/75	45°	0	105	185	10/1
CODA776	110/75/75	67°30'	22	78	67	10/1
CODA778	110/75/75	87°30'	50	35	150	10/1
CODAAA4	110/110/110	45°	25	134	134	10/1
CODAAA6	110/110/110	67°30'	40	86	86	10/1
CODAAA8	110/110/110	87°30'	57	62	62	10/1

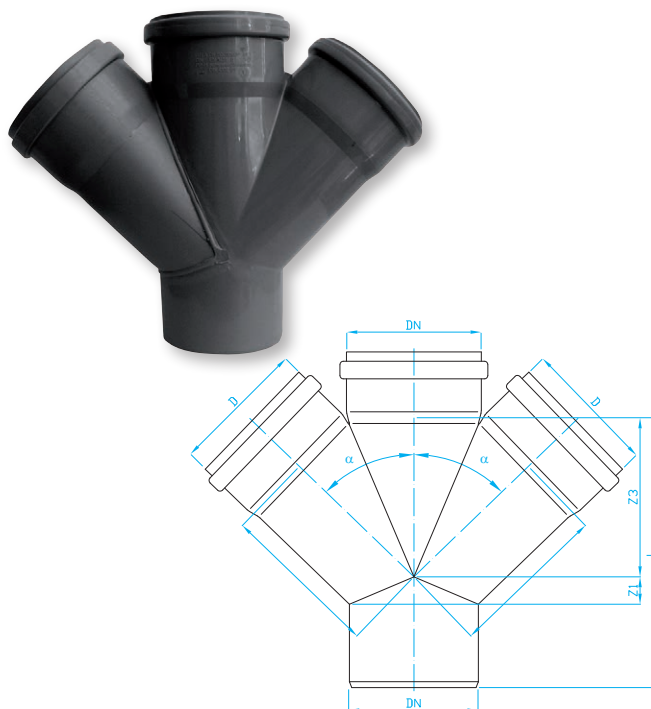

## HTED Rohová odbočka

Corner branch  
Eckabzweige  
Панельные отводы

ART.	DN/D/D	$\alpha$	L	Z1	Z2	Z3	balení ks
COR5554	50/50/50	45°	124	12	61	61	10/1
COR5556	50/50/50	67°30'	124	20	41	41	10/1
COR7776	75/75/75	67°30'	153	28	59	59	10/1
CORA554	110/50/50	45°	135	-17	104	91	8/1
CORA556	110/50/50	67°30'	135	8	73	54	8/1
CORAAA4	110/110/110	45°	202	25	134	134	8/1
CORAAA6	110/110/110	67°30'	202	40	86	86	10/1
CORAAA8	110/110/110	80°30'	185	60	93	60	10/1

